



QDS 150W Manual

2 Output 150W Quad Colour LED Strip Driver

Disclaimer: Ledion Lighting strongly believes that the information provided in this manual is correct at the time of publishing. However, Ledion Lighting and its affiliated companies are not responsible to any loss, accident, damage or disruption caused by any errors or misinformation within this document. Ledion Lighting reserves the rights to revise the content within this manual without any obligation to notify any person or company of such revisions. Ledion Lighting has no obligation nor reason to execute any revisions within this document.

Usage: This document has been provided for the intended use of providing the latest information on the QDS 150 and its contents. This document has been created for the use of Ledion's customers to print, download and store for future reference and guidance. Please check you have the latest revision of this document by visiting our website: www.ledion.co.uk/manuals

Copyright: The content, illustrations and logos written within this document are solely owned by Abstract AVR Ltd. Abstract restricts the right for any unauthorised person to modify, copy or sell this document. Copyright © 2026 Abstract AVR Ltd t/a Ledon Lighting. All rights reserved.

Introduction:

Capable of running 30m of 19.2W/M RGBW LED strip.

Ideal for a wide variety of applications from home cinemas, to film and tv. This driver is perfect for taking care of those medium sized projects where up to 30 meters of colour change LED strip needs powering. With super smooth 16bit dimming and unrivalled RGB + tuneable white control.

Product code: QDS-150

Compatible with: RGB/RGBW 24V LED Strip

Claims

Unpacking: Open the outer packing box taking care not to scratch the product inside when doing so. Handle the contents with care when removing them from the packaging, and check for any damage. If the outer box appears to be damaged or is showing signs of mishandling from shipping, please report to the carrier immediately. Time & dated photos can dramatically help when processing a mishandling claim.

Please recycle any packaging where possible.

Missing items: If you feel you are missing any components or parts that are included within the pack contents, please report directly to Ledion Lighting within 3 working days of delivery.

Support contacts: Ledion Lighting provides a range of support channels to assist you with any problems you may occur when setting up or using your QDS 150. Some of these channels include:

Landline: +44(0)1162 788 078

Email: sales@abstract.co.uk

Website: www.ledion.co.uk

Forum: ledion.co.uk/forum

Youtube: Ledion Lighting

Opening hours: 9am - 5pm | Monday - Friday

CONTENTS

Introduction	3
Safety precautions	5
Product overview	6
Product dimensions	6
Wiring	7
Wiring diagram	7
Connecting LED outputs	8
DMX & controller wiring	9
Initial startup	10
Menu settings	11
Output settings	11
Test mode	12
Device options	12
DMX configuration	13
DMX setup	13
Setting the DMX address	13
DMX channel modes	14
Master/Slave	14
DMX personalities	15
WIFI settings	18
Connecting to WIFI	18
Maintenance	19
Specifications	20
Frequently asked questions	21
Warranty & Returns	22

Warnings: Ensure you read the instruction manual before using.

To prevent or reduce the risk of electrical shock or fire, do not expose this unit to rain or moisture. You must disconnect the unit from the mains by removing the plug from the supply socket BEFORE cleaning or carrying out maintenance and when replacing parts.

Safety notes: These safety notes include important information about the safe operation, installation and maintenance regarding the QDS 150.

DO:

- Connect to mains power supply ensuring an earth is present.
- Store in a dry place, intended for indoor use only.
- Disconnect from power supply when not in use to save component life.
- Replace fuse with same type and rating.
- Always mount this unit in a safe and stable manner.
- Be sure your power supply is suitable for the voltage stated for this unit.
- Mount unit in area supplied with adequate ventilation.
- Be sure to complete all rigging and installation procedures before connecting the main power cord to the appropriate power supply.

DO NOT:

- Expose unit to rain or moisture.
- Spill water or other liquids onto your unit.
- Operate this unit if the power lead is frayed or broken.
- Operate this unit with its cover removed.
- Attempt to operate this unit if it is damaged in any way.
- Look directly at the light source when the unit is on.
- Allow flammable material close to the unit.
- Block any ventilation hole or slots within the unit housing.
- Use outdoors or submerge.
- Allow cables to be walked over, pinched or snagged.
- Open this unit to attempt any repairs.

Cautions:

- If unit malfunctions, stop using immediately and remove power source.
- Unit may get hot when in operation
- Units may fall over if knocked into or snagged.
- Cleaning this unit should be done with care by following the *Cleaning* section of this manual.

QDS 150 Includes:

- 1x QDS 150
- 1x IEC mains power lead
- 2x 5 pin phoenix green plugs



Optional Accessories:

- 5 pin phoenix green LED plug
- 5m cat5 cable
- 5m 3 pin XLR cable
- 5m 5 core flat ribbon

QDS 150

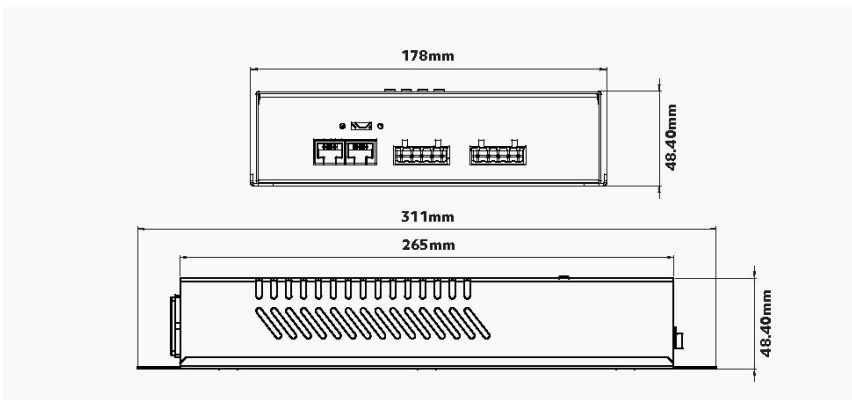



Example Schematic QUAD DRIVER S 150

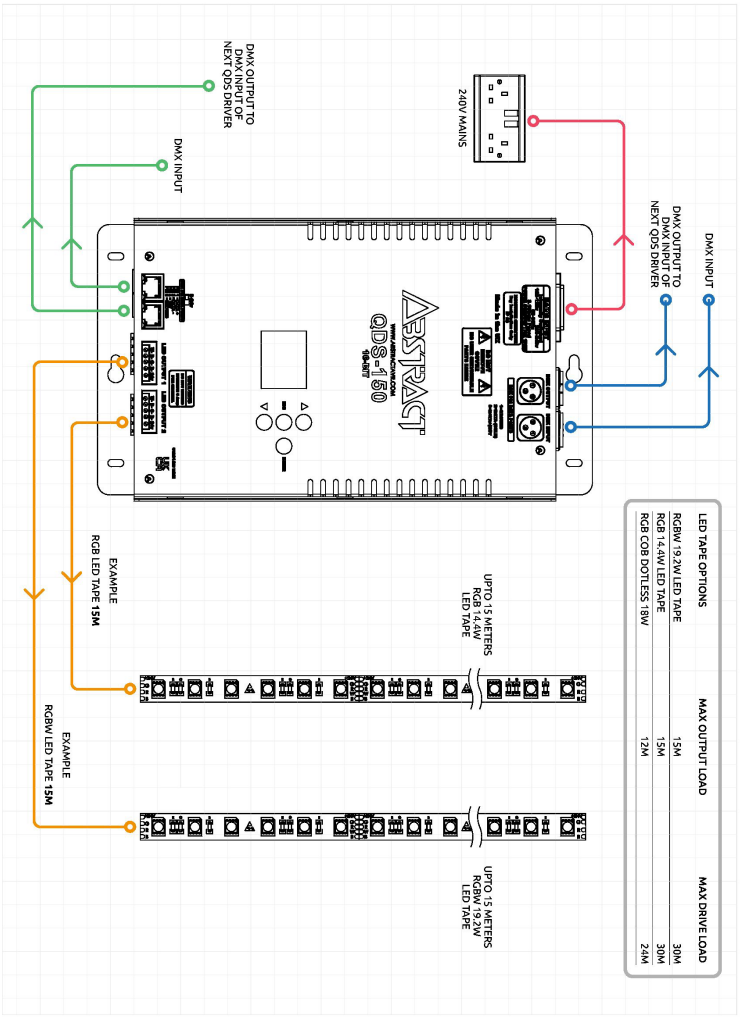

Firstly install your LED strips in their desired location
Connect them to your QDS driver units using 5-core cabling (for RGBW).
The LED strips connect to the 5 way terminal blocks.

See figure

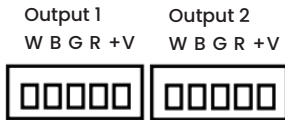

- Terminal 1 = White negative
- Terminal 2 = Blue negative
- Terminal 3 = Green negative
- Terminal 4 = Red negative
- Terminal 5 = positive common

If single colour LED tape is being used, the positive connections must be commoned in terminal 5. For single colour tapes the output channels are now numbered:

- Terminal 1 = Channel 4
- Terminal 2 = Channel 3
- Terminal 3 = Channel 2
- Terminal 4 = Channel 1
- Terminal 5 = positive common

Caution: Ensure that no electrical part of the LED strips have shorted to any metalwork. LED shorts may cause stray voltages which will prevent the DMX control system from working. There are different model variants for both 12V and 24V strips. Do not connect 12V LED to a 24V driver unit as the tape may become damaged. If 24V LED is connected to a 12V driver unit, no damage will be caused but only the red LEDs will operate. If lengths of strip over 5 metres are being used, run a second feed cable to the far end of the tape, connected into the same terminals on the driver. LED strips can only carry a limited amount of current and over a long length the blue and green LEDs at the end of the tape will become dim. Position the driver as close to the LED tape as possible, long cable runs will cause volt drop and loss of brightness. Install a mains power feed to the QDS unit. If your installation includes several QDS units, you can control them all together by linking them using either 3 pin XLR or Cat5/RJ45 (DMX) cables.

5 way connector for LEDs

- Pin 1 White / Ch4-
- Pin 2 Blue / Ch3-
- Pin 3 Green / Ch2-
- Pin 4 Red / Ch1-
- Pin 5 positive common

3 way XLR connector for DMX

- Pin 1 Gnd
- Pin 2 Data -
- Pin 3 Data+

8 way RJ45 connector for DMX

- Pin 1 Data+
- Pin 2 Data -
- Pin 3 Gnd
- Pin 4 +24V controller supply
- Pin 5 +24V controller supply
- Pin 6 +24V controller supply
- Pin 7 Gnd
- Pin 8 Gnd

Compatible with Ledion LUC02 DMX controller

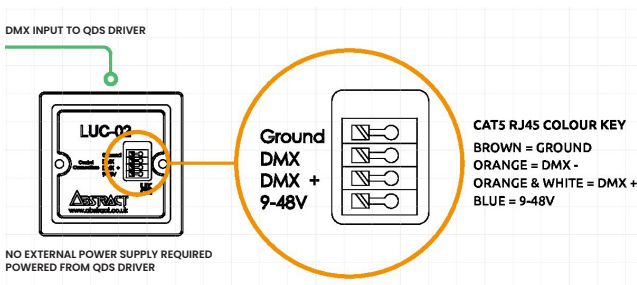

We recommend commencing initial start up without any DMX cables connected to the QDS Driver to avoid any confusion. For learning how to set up DMX, please see page 14 (DMX Settings).

Once you have wired up your LED Strips to the QDS Driver you are now ready to power up. Plug in your provided IEC mains power lead to the QDS Driver and the display screen will light up. See *fig 1*

Figure 1

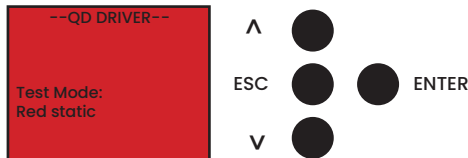

On initial startup you will be presented with an red backlit background with Test mode displayed at the bottom. You are now in Ledion's Test mode. In this mode you can scroll through a range of built-in static colours.

To scroll through the presets, simply press the **'up' and 'down'** buttons to navigate through the menu.

Presets Layout – scroll menu using enter & esc

All Off

Red Static

Yellow Static

Green Static

Cyan Static

Blue Static

Magenta Static

White Static

All Static

RGB Sequence

RGBW Sequence

Rainbow Sequence

CCT Sequence - A range of white colour temperatures

CCT Manual - 2300k - 7000k as set in 'White Colour Temp' - See next page

Stored Scene - as stored in 'Store DMX Scene' options

On initial start up you may need to adjust your output settings to suit your required usage. To do this we will need to go into the Main Menu. To enter the Main Menu, press and hold the **'Enter'** button for at least 3 seconds. To exit the Main Menu press the **'Esc'** button. See *fig 2*

Figure 2

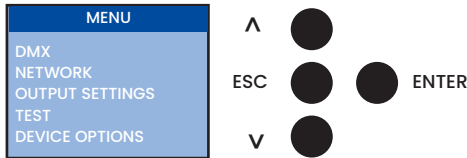

When in the Main Menu, use the **'up and down'** arrows to scroll to **'Output Settings'** and press **'Enter'**. You will now see the output settings sub-menu.

Control mode - allows you set your dmx channel mode (2, 3, 4, 5)

Single chan mode - allows you to set whether you control your led outputs as combined group or individually

Dim resolution - Select between 8 bit and 16 bit dimming resolution. 8 bit + 16 bit smoothing is out most advanced flicker free dimming.

PWM Frequency - Select between 1000Hz, 4000Hz, 16000Hz & 32000Hz.

White colour temp - sets the colour temperature of 'CCT Manual' from a range of white temperatures (2300k - 7000k).

Calibration - allows you to set individual brightness levels for each colour.

Power balancing - allows you to run more LED from your QDS Driver by using Ledion's power balancing mode. *Default set to On.*

QDS has a built-in standalone mode for instant light shows out of the box. You can alter the test mode by selecting 'Test' within the Main Menu.

Test mode enable - allows you to switch test mode on and off.

Pattern - set the default test effect.

Speed - set the speed of the colour scroll.

Fade - set the fade on/off for the colour scroll.

Sound - set the sound to light on/off.

Store DMX scene - captures current dmx input and stores onto Test mode - Stored Scene.

Device options allows you to make changes to your QDS driver settings.

Display Mode - Blank after 30 seconds. Show DMX address. Always on.

Factory reset - Factory resets your device to the default factory settings.

About - Shows model and firmware versions. *v1.0.19 current latest*

To connect your QDS driver to DMX software you will need to connect to it via a 3 Pin XLR or Cat5/RJ45 cable into the DMX input. Once connected, your QDS driver will display a green background (DMX mode) and the DMX address as set in the DMX settings. See *fig 3 & 4*

Figure 3

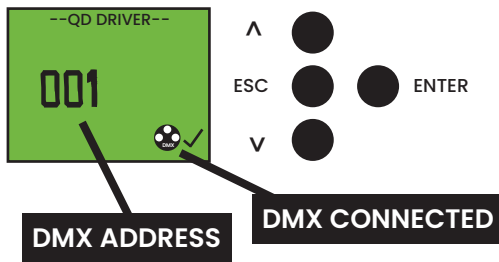
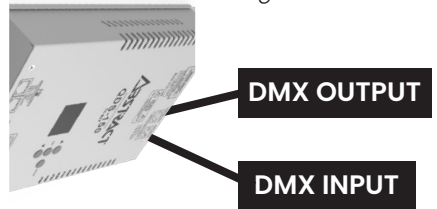

Figure 4



To set your QDS driver DMX address, you simply need to enter back into the Main Menu and select 'DMX'. You will then be presented with the following options.

DMX address start - *Default 001*

Out 1 address - *Default auto*

Out 2 address - *Default auto*

By selecting DMX address start, it will then allow you to change the DMX address of the QDS Driver unit. If required you can select either 'Out 1 address' or 'Out 2 address' to set an individual DMX address for each LED Output. If left in 'Auto' this will be done for you depending on which channel mode you have selected.

Example if using Auto & 001 start address in 4 channel mode:

1st output will be 001,

2nd output 005. *Set automatically for you.*

The QDS driver comes with various channel modes to aid with programming for a wide range of application.

The following channel modes are available:

- 2 channel mode - warm white, cool white control
- 3 channel mode - rgb control
- 4 channel mode - rgbw control
- 5 channel mode - rgbw + cct white

LED outputs can be controlled individually or as a singular group by going to the **'Output settings'** in the Main Menu and selecting **'Single channel mode'** > On/Off. On = grouped control | Off = individual control

Overturn to see the personalities for each channel mode.

Multiple QDS drivers can be controlled together by traditional Master/Slave. Link your QDS drivers together using either a 3 pin XLR or Cat5/RJ45 DMX cable via the relevant DMX input and output connections, and set the DMX addresses accordingly.

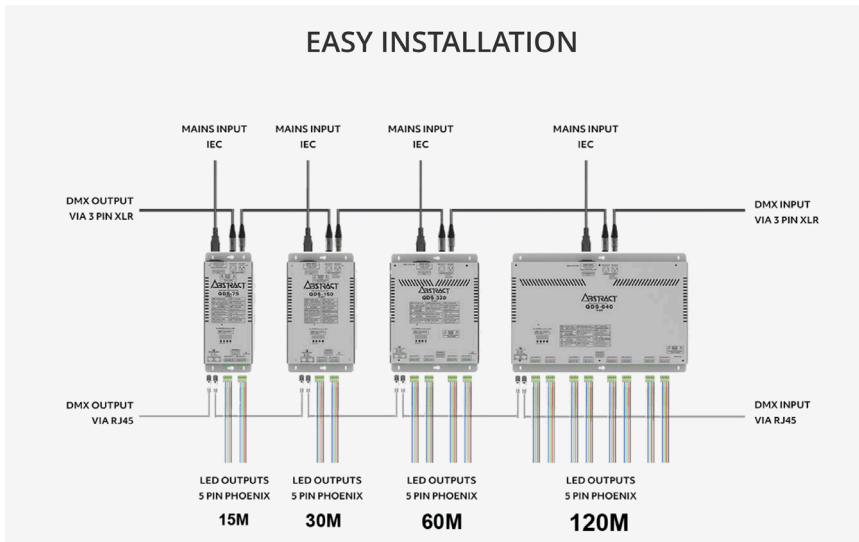

Dim resolution:

8 bit

8 bit + 16 bit smoothing

2 Channel Mode

Slider	Function	Value	Setting
1	Warm White	000 > 255	0-100%
2	Cool White	000 > 255	0-100%

3 Channel Mode

Slider	Function	Value	Setting
1	Red	000 > 255	0-100%
2	Green	000 > 255	0-100%
3	Blue	000 > 255	0-100%

4 Channel Mode

Slider	Function	Value	Setting
1	Red	000 > 255	0-100%
2	Green	000 > 255	0-100%
3	Blue	000 > 255	0-100%
4	White	000 > 255	0-100%

5 Channel Mode

Slider	Function	Value	Setting
1	Red	000 > 255	0-100%
2	Green	000 > 255	0-100%
3	Blue	000 > 255	0-100%
4	White	000 > 255	0-100%
5	CCT	000 > 255	0-21=2300 22-43=2500 44-65=2700 66-87=3000 88-109=3500 110-131=4000 132-153=4500 154-175=5000 176-197=5500 198-219=6000 220-241=6500 242-255=7000

Dim resolution:

16 bit

2 Channel Mode

Slider	Function	Value	Setting
1	Warm White (Course)	000 > 255	0-100%
2	Warm White (Fine)	000 > 255	0-100%
3	Cool White (Course)	000 > 255	0-100%
4	Cool White (Fine)	000 > 255	0-100%

4 Channel Mode

Slider	Function	Value	Setting
1	Red (Course)	000 > 255	0-100%
2	Red (Fine)	000 > 255	0-100%
3	Green (Course)	000 > 255	0-100%
4	Green (Fine)	000 > 255	0-100%
5	Blue (Course)	000 > 255	0-100%
6	Blue (Fine)	000 > 255	0-100%
7	White (Course)	000 > 255	0-100%
8	White (Fine)	000 > 255	0-100%

5 Channel Mode

Slider	Function	Value	Setting
1	Red (Course)	000 > 255	0-100%
2	Red (Fine)	000 > 255	0-100%
3	Green (Course)	000 > 255	0-100%
4	Green (Fine)	000 > 255	0-100%
5	Blue (Course)	000 > 255	0-100%
6	Blue (Fine)	000 > 255	0-100%
7	White (Course)	000 > 255	0-100%
8	White (Fine)	000 > 255	0-100%
9	CCT	000 > 255	0-21=2300 22-43=2500 44-65=2700 66-87=3000 88-109=3500 110-131=4000 132-153=4500 154-175=5000 176-197=5500 198-219=6000 220-241=6500 242-255=7000

The QDS driver has its own built-in WIFI hotspot or can join to an existing WIFI network. Once connected, the QDS driver outputs can be controlled and programmed via Ledion's WIFI control software.

Connecting to QDS driver built-in WIFI

To connect to your QDS driver built-in WIFI you need to ensure that WIFI Mode is switched on.

Go to: Main Menu > Network > WIFI Mode > Self-AP

Important: Once WIFI is switched on you will need to restart your QDS driver to activate WIFI mode.

Once you've switched on the built-in WIFI and restarted your QDS driver you are now ready to connect.

Open your network settings within your smart device (phone, tablet, laptop or computer) and look for 'ABS-DRIVER-XXXX' (X being a unique ID). Once connected you will be prompted to enter a 9 digit password for every devices first time connection. Enter the WIFI password '123456789', this is the default factory password. You can change this in the app settings later.

Once connected to 'ABS-DRIVER-XXXX' WIFI you can now open your internet browser and enter the QDS driver IP Address 192.168.4.1
You can now save this a shortcut to your desktop or smart device home screen.

You should now see the following.

QDS driver

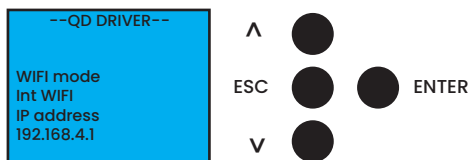

Smart device



Fuse Replacement

Disconnect the QDS driver from the power supply and allow 10 seconds for any excess power to fully discharge. Use a flat head screwdriver to remove the fuse holder located directly underneath the power input socket. Remove the fuse and replace with new. Check to ensure the new fuse has the same rating as the factory installed fuse. Secure fuse holder back into housing and re-connect power to test.

Cleaning

Over time your QDS driver could form a build up of dirt and dust which may cause long term damage to your unit. To avoid this we recommend regular cleaning intervals, increased with heavier usage and more challenging environmental conditions.

The following cleaning method is recommended:

QDS 150

1. Unplug your QDS driver from its power supply.
2. Wait for 10 seconds for the unit to fully discharge any excess power.
3. Use a vacuum or dry compressed air with a soft brush to remove any excess dirt or dust from the aluminium housing.
4. The driver housing can be cleaned with a mild soap solution, ammonia free glass cleaner and water.
5. Apply the solution directly to a soft cloth or lens cleaning wipe.
6. Drag any excess dirt the to edges of the frosted lens and collect.
7. Gently wipe off excess solution with a soft cloth until lens is free of marks and smears.
8. Ensure the QDS driver is completely dry when finished.

Specifications

Technical Specifications

Channels

2/3/4/5

Programming & Control

Ledon LUC02 RGBW controller or via external DMX software

Power Input

100-240VAC

Wattage

150W

Output Voltage

24V

Output Current

5A per channel

LED Capability

30m of RGBW 24v LED strip

IP Rating

IP20

LED Type

SC/RGB/RGBW/RGB+Tunable White

Housing

Powder Coated Aluminium

LED Connection

5 Pin Phoenix

DMX Connection

3 pin XLR or Cat5/RJ45

Operating Temp Range

-10 to 30 °C

Compatible With

24V LED Strip, LUC02 Controller

Frequently Asked Questions

Below you will find answers to the most common questions you may have on the QDS driver range. Also please feel free to Contact Us if you still can't find what you are looking for.

What is Power Balance Mode?

Power balancing mode is a specially designed software within our LED drivers that allows you to balance the power across all of your LED's so they all output the same, avoiding any voltage drop. This allows you to run more LED Tape than your typical LED tape driver.

Are they WIFI compatible?

Yes, using the menu you can turn the WIFI on and connect to your phone/tablet.

What voltage is the QDS 150 driver?

The QDS 150 requires a 230v input which then transforms down to provide a fixed output of 24V to any RGB/W LED Strip.

How many meters of LED Strip can I run from a QDS 150?

A QDS 150 is capable of running 30m of RGB/W LED Strip using its built in power balance mode.

Are constant voltage LED drivers dimmable?

Yes, our QDS 150 has dimming capabilities but must be dimmed through an external dimmer/controller. An example would be the LUC02 controller.

Warranty and returns

Warranty

The QDS 150 carries a 2 year structured warranty from date of purchase. As standard an automatic 1 year back to base warranty is applied from factory. You will need to register your Ledion products online to receive a further 1 year parts and labour warranty by visiting www.ledion.co.uk/warranty. See the warranty card within your box for more detailed instructions on how to register.

Returns

When returning units whether under warranty or not, it must be accompanied with a Ledion unique returns number, please contact Ledion Lighting customer support for a URN number. **Do not** send your product to us if you have not yet secured a URN number. If the unit is under warranty, you must provide a copy of your proof of purchase invoice and send via email or place inside the returns box. Ledion Lighting is not responsible for delays in repairs and shipping.

Products not under warranty

When obtaining your URN number, please notify customer services that your product is no longer within warranty. You will then be contacted by Ledion with a quotation for the repair including shipping charges. All authorised Ledion repairs will be complete with a 90 day labour and material repairs warranty starting from the date of shipping.

Shipping

When shipping units back to Ledion, products must be adequately packed and insured by you. Any damage during return shipment, whether due to inadequate packing or carrier mishandling is your sole responsibility. Double box all returns and surround it with suitable packing materials, such as bubblewrap, foam inserts and styrofoam balls.

Repair Tracking

Once we have received your returns you will receive a link via email to our online repairs tracking system, where you can check for regular updates on the repair work and its status.

This page has been left intentionally blank.



Made In Britain. Trusted Worldwide.

Contact Us

Abstract AVR Ltd
Westfield,
Rear of 24/26,
Leicester Road,
Blaby,
LE8 4GQ
United Kingdom

+44(0)116 278 8078
sales@abstract.co.uk
www.abstract.co.uk